

ENGINEERING GRAPHICS AND DESIGN

INGENIEURSGRAFIKA EN -ONTWERP

PAPER 1

VRAESTEL 1

MEMORANDUM

GR 11

NOVEMBER 2014

This memorandum consists of 6 pages.

Hierdie memorandum bestaan uit 6 bladsye.

ANSWERS		
1	PP140	1
2	3	1
3	NEW TV ROOM ADDED	1
4	CRADOCK	1
5	006	1
6	STEPS	1
7	BUILT IN CUPBOARDS	1
8	FINISHED FLOOR LEVEL	1
9	NORTH	1
10	NATURAL GROUND LEVEL	1
11	2	1
12	SOUTH ELEVATION	1
13	SECTION A-A	1
14	TILES	1
15	THREE	1
16	WC	1
17	$(12000 \times 2) + (9600 \times 2)$ = 24000 + 19200 = 43,2 meters	4
18	2200×2700 = 2,2 x 2,7 = 5.94 m ²	4
19		6
	TOTAL	30

ANTWOORDE		
1	PP140	1
2	3	1
3	NUWE TV KAMER BYGEVOEG	1
4	CRADOCK	1
5	006	1
6	TRAPPE	1
7	INGEBOUDEKASTE	1
8	VOLTOOIDE VLOERVLAK	1
9	NOORD	1
10	NATUURLIKE GRONDVLAK	1
11	2	1
12	SUIDAANSIG	1
13	SNIT A-A	1
14	TEËLS	1
15	DRIE	1
16	WC	1
17	$(12000 \times 2) + (9600 \times 2)$ = 24000 + 19200 = 43,2 meter	4
18	2200×2700 = 2,2 x 2,7 = 5.94 m ²	4
19		6
	TOTAAL	30

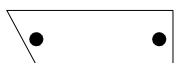

FREEHAND
● VRYHAND



FREEHAND
● VRYHAND

MEMORANDUM

Copyright reserved

PAPER 1 QUESTION 2
GR 11 NOVEMBER 2014

VRAESTEL 1 VRAAG 2
GR 11 NOVEMBER 2014

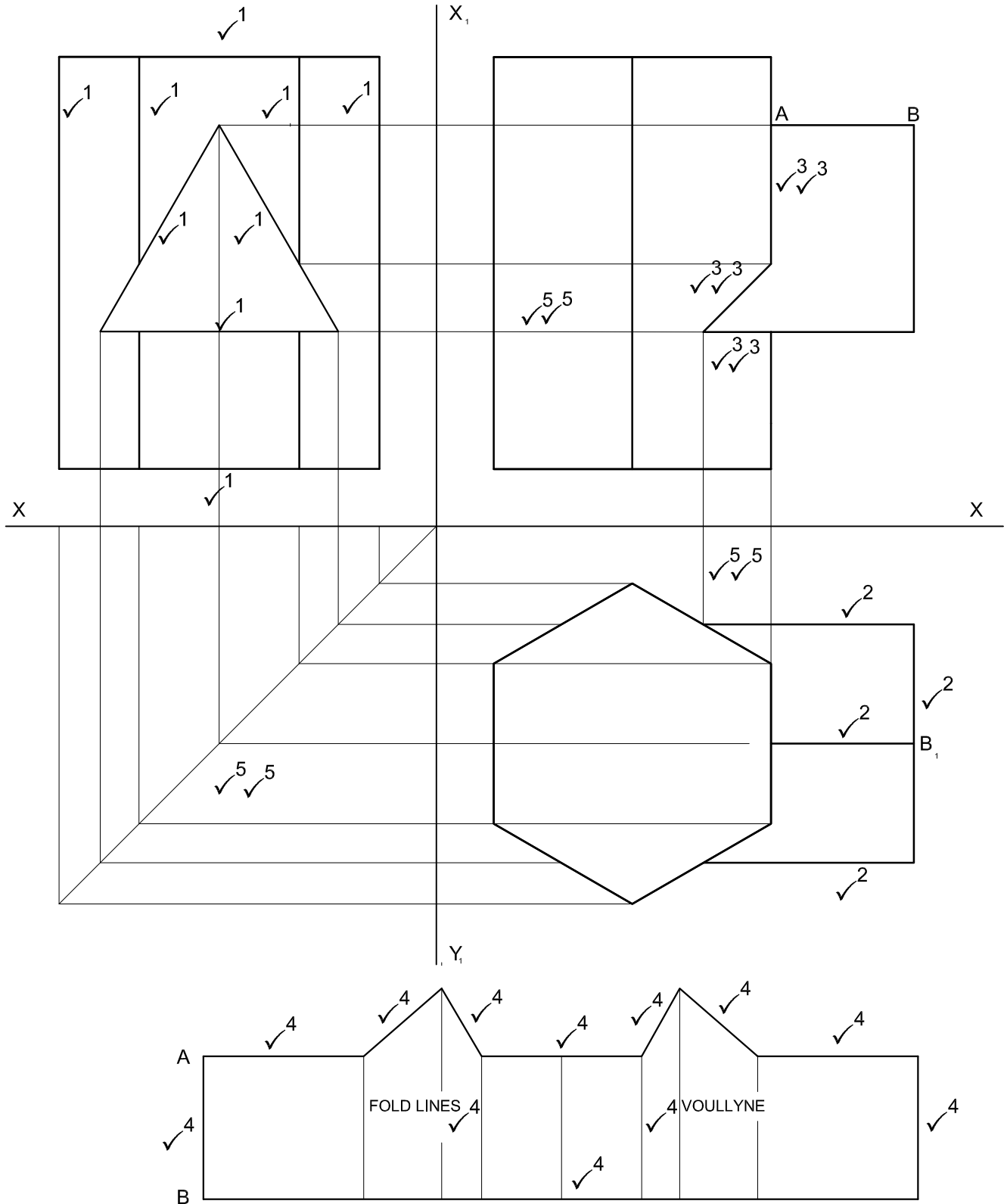

ASSESSMENT CRITERIA		ASSESSERINGSKRITERIA	
1 Completed right view	9	1 Voltooid regteraansig	9
2 Completed top view	4	2 Voltooid boeaansig	4
3 Curve of interpenetration	6	3 Deurdringingskromme	6
4 Development	12	4 Ontwikkeling	12
5 Constructions	6	5 Konstruksies	6
TOTAL	37	TOTAAL	37

MEMORANDUM

ASSESSERINGSKRITERIA		ASSESSMENT CRITERIA	
1 Verdwynpunte	6	1 Vanishing points	6
2 Konstruksies	4	2 Constructions	4
3 Trappe 22 x ½	11	3 Steps 22 x ½	11
4 Mure 20 x ½	10	4 Walls 20 x ½	10
5 Venster 10 x ½	5	5 Window 10 x ½	5
TOTAAL	36	TOTAL	36

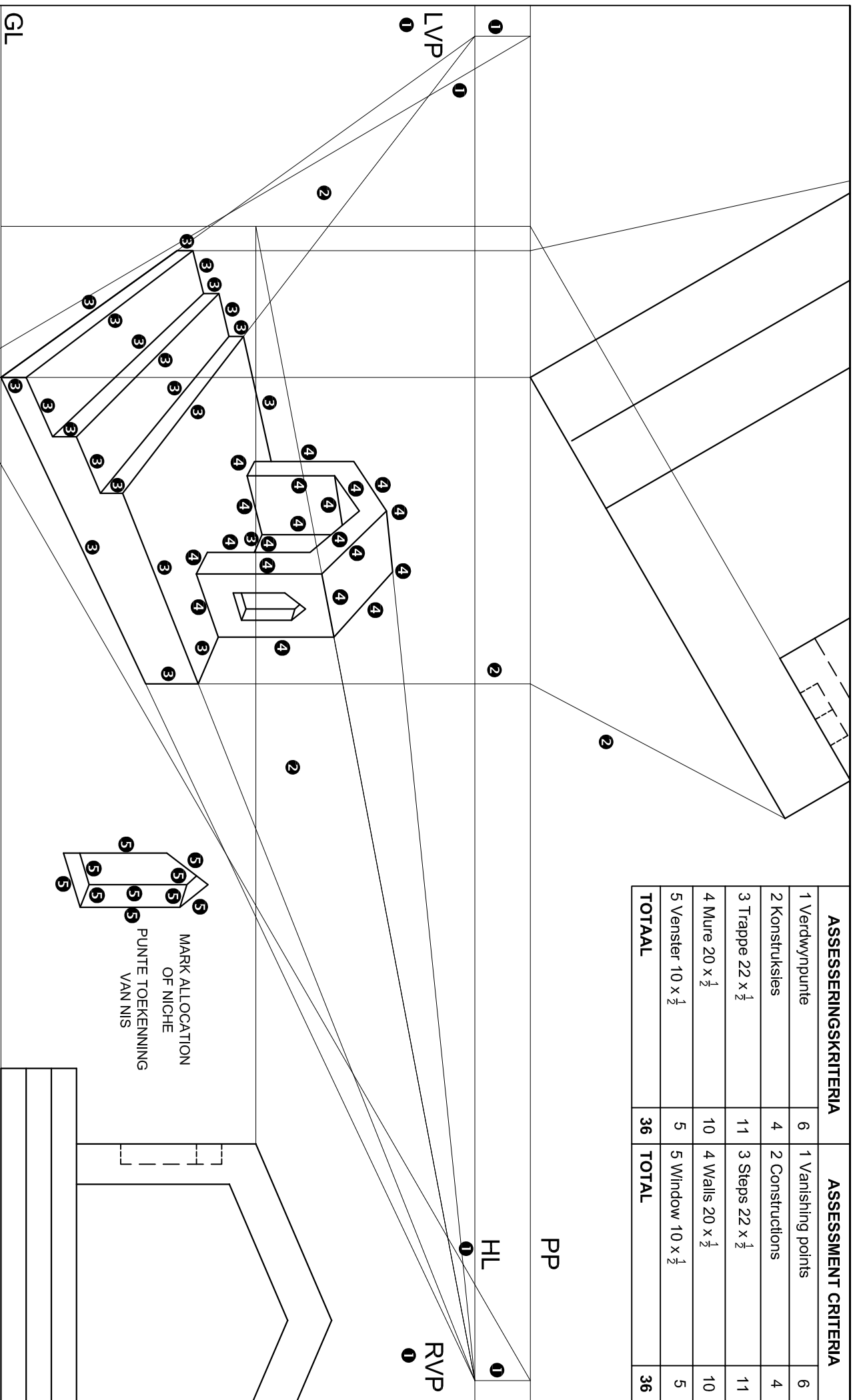

MEMORANDUM

PAPER 1 QUESTION 3
GR 11 NOVEMBER 2014

SP

Copyright reserved

VRAESTEL 1 VRAAG 3
GR 11 NOVEMBER 2014

VRAESTEL 1 VRAAG 4
GR 11 NOVEMBER 2014

PAPER 1 QUESTION 4
GR 11 NOVEMBER 2014

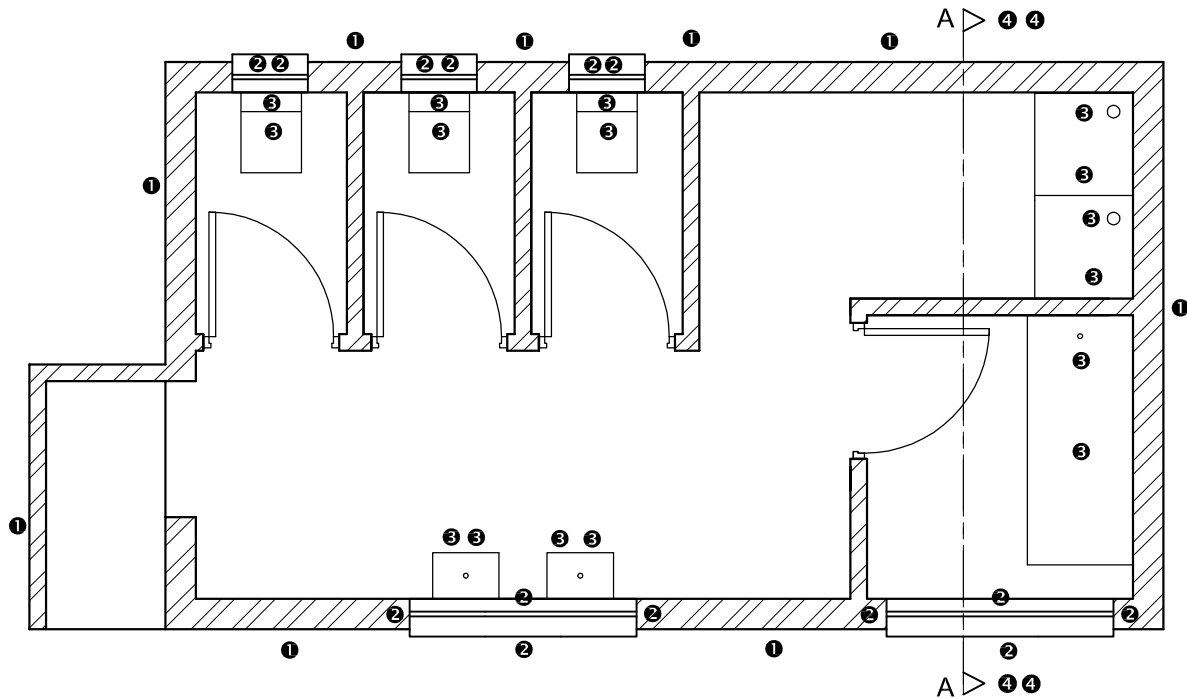
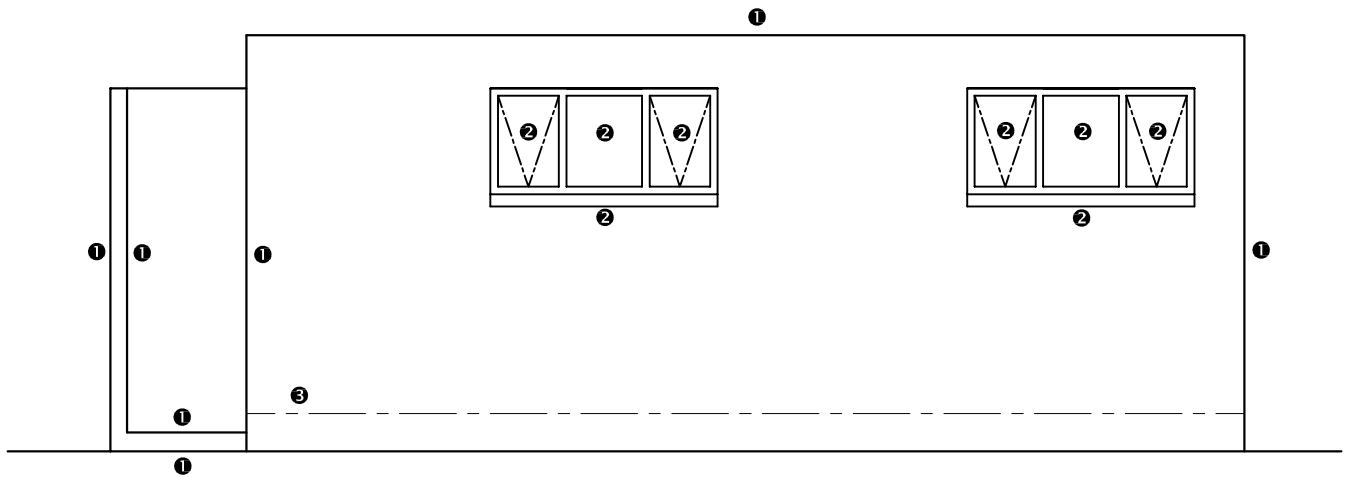

FLOOR PLAN	
1 HATCHING	9
2 DOORS AND WINDOWS	14
3 SANITARY FIXTURES	16
4 CUTTING PLANE	4
SUB TOTAL	43
SOUTH ELEVATION	
1 EXTERIOR WALLS AND CEILING	7
2 WINDOWS	8
3 FFL	1
SUB TOTAL	16

VLOERPLAN	
1 ARSERING	9
2 DEURE EN VENSTERS	14
3 SANITÊRE TOEBEHORE	16
4 SNIYVLAK	4
SUBTOTAAL	43
SUIDAANSIG	
1 BUITEMURE EN PLAFON	7
2 VENSTERS	8
3 VVV	1
SUBTOTAAL	16

NB
MEMORANDUM
CONTINUES ON PG 6

MEMORANDUM

Copyright reserved

LW
MEMORANDUM VOLG
AAN OP BL 6

VRAESTEL 1 VRAAG 4
GR 11 NOVEMBER 2014

PAPER 1 QUESTION 4
GR 11 NOVEMBER 2014

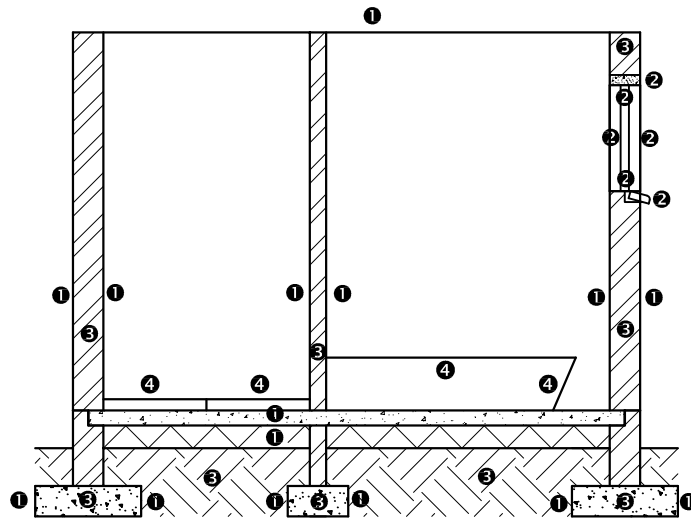

SECTIONAL ELEVATION A-A

SNITAANSIG A-A

5 5

SECTIONAL ELEVATION	
1 FOUNDATION AND WALLS	15
2 WINDOW AND LINTELS	6
3 HATCHING	11
4 SANITARY FIXTURES	4
5 LABELS	2
SUB TOTAL	38
TOTAL	97

SNITAANSIG	
1 FONDASIE EN MURE	15
2 VENSTER EN LATEI	6
3 ARSERING	11
4 SANITÊRE TOEBEHORE	4
5 BYSKRIFTE	2
SUBTOTAAL	38
TOTAAL	97

MEMORANDUM